



Research Paper

Internet of Things for In Home Health Based Monitoring System: Modern Advances, Challenges and Future Directions

Omer Iqbal¹, Tayyeba Iftakhar², Saleem Zubair Ahmad³

¹ Superior University, Pakistan,

ABSTRACT

IOT has carried out important function in converting the traditional fitness care corporation. With developing call for in population, traditional healthcare structures have reached their outmost functionality in presenting sufficient and as plenty as mark offerings. The worldwide is handling devastating developing antique population disaster and the right want for assisted-dwelling environments is turning into inevitable for senior citizens. There furthermore a determination by means of the use of way of countrywide healthcare organizations to increase crucial manual for individualized, right blanketed care to prevent and manipulate excessive coronial situations. Many tech orientated packages related to Health Monitoring have been delivered these days as taking advantage of net boom everywhere on globe, manner to improvements in cellular and in IOT generation. Such as optimized indoor networks insurance, community shape, and fairly-low device fee performances, advanced tool reliability, low device energy consumption, and hundreds higher unusual common usual performance in network safety and privacy. Studies have highlighted fantastic advantages of integrating IOT with health care location and as era is improving the rate also cannot be that terrific of a problem. However, many challenges in this new paradigm shift notwithstanding the fact that exist, that need to be addressed. So the out most purpose of this research paper is 3 essential departments: First, evaluation of key elements that drove the adoption and boom of the Internet of factors based totally domestic some distance off monitoring; Second, present fashionable improvement of IOT in home a long manner off monitoring shape and key building gadgets; Third, communicate future very last effects and distinct guidelines of such type a long way off monitoring packages going ahead. Such Research is a wonderful manner in advance now not outstanding in IOT Terminology but in standard fitness care location.

Keywords: Ambient assisted living, body sensor, E-Health, Internet of Things, IoT In-home, M-Health, Remote monitoring, Middleware, Reliability, Remote Monitoring, Smart health Care, Tutorial. Internet of things Smart home,

*Received 24 July, 2021; Revised: 07 August, 2021; Accepted 09 August, 2021 © The author(s) 2021.
Published with open access at www.questjournals.org*

I. INTRODUCTION

IN-HOME fitness tracking permits affected character care to maintain at domestic after an affected man or woman is discharged from the medical institution. It lets in healthcare vendors to reap sufferers out of doors of the 4 partitions of the health facility, perform proper monitoring of affected character fitness situations, maintain to deliver incredible care and end up aware of at-hazard populations. It also allows the patient to keep in contact with their health care providers, stay compliant with rehabilitation programs, and maintain their situation. One of the most important signaling health (m-Health) programs that deliver proactive digital primary care is IoT-based entirely in-home fitness monitoring [1]. and [2]. "A huge overarching time span embracing e-Health (which includes m-Health), and also some new fields, which include the application of strong computing sciences in 'gigantic records,' genomics, and artificial intelligence," and according to National Institutes of Health [2].m-Health, from the other hand, can be described as the time of cell computing, medical sensors, and connectivity in health care [3]. Well over years, there's been a sharp increase in the number of m-Health package options required and around universe. As a basis, according to Global Market Trends, the m-Health Market was worth \$289.4 billion by 2025 [5]. The advent of m-Health systems and in-home monitoring devices has now been boosted by three important factors.

A. Present healthcare services boundaries and fitness policymakers' planning instructions.

The percentage of people aged 65 and up is increasing faster than just about every other age group on earth. Based on Government predictions, the total number of people over 60 years old could substantially double between 2015 and 2050, from 12 percent to 22 percent. Nearly 80% of adults over the age of 65 have at least two individual problems, with 77 percent having at least [4]. The anticipated "Silver Tsunami" will take more modalities and caregiving, putting that much more strain on the country's already disoriented healthcare system. In the coming days, identifying a competitive advantage as well as utilizing millennials to promptly and effectively control people's athletic performance may well be a critical component in checks and balances excellent service. As a corollary, the strategy and part of the world plan, and also some global health authorities, are developed to treat human beings remotely using resources available. The World Health Organization (WHO) finally updated taxonomy for defining digital health services [2]:

- Customer encroachments: Clients were also persons who are great promise or chopping wellness clients.
- Medical service intrusions: Healthcare sellers are people who work in the sports industry and offer track team.
- Health system or service provider's intrusions: Executives are related to the management and design of health care institutions.
- Data facility intrusions: This assurance to aid managing quickly gaining, maintenance, and process.
- To do manual record series, administration, and processing tasks.

A long-distance remote-health-tracking program consists of the mitigate intervention tool in most the above outcome measures. Remote health tracking programs utilize sensors and a household hub to connecting the user and health care professionals and policy makers via cloud information resources. The Health Care System (NHS) is shifting models to preserve adult patients with chronic and at media sites, lowering disease, cost, and alleviating poverty in the face of a shortfall of social care supplies. NHS UK, for example, proposes five amendments to the NHS provider model in order to achieve organizational objectives [6]:

- Improvement out of hospital carefulness: To dissolve the ancient divide between number one and network health offerings.
- NHS redesign: To lessen strain on emergency offerings at hospitals.
- Enabling patients and adapted care: Patients to get extra control over their fitness.
- Numerically empowered care: To be part of the primary and outpatient care pathways throughout the NHS.

The far-flung mobile healthcare applications are both an easy jet of these 5 most critical sensible adjustments to the health organization version. Above it indicated 'out of cloister' treatment, reduced emergency medical effective to treat, custom built digitally allows treatment, and blanket care global way can't exist without the use of distant intrusion prevention applications. Certainly, one of the reasons for its popularity m-Health market is the rapid growth interest in molecular diagnostics and personal care [5].

B. The advances inside the underlying permitting technology in terms of cellular telephone abilities, wireless communications, sensors, wearable's and IoT architectures and protocols.

Because with the enormous popularity of handsets and the cheapness of m-Health training, it is a sustainable financing option everywhere from over world, in 2017, it is forecasted that 500 million new smartphones from China and India will have reconnected toward the internet, the world's closest friend. [5] The Internet of Things (IoT) is an incredibly quickly IT revolution that has been triggering a paradigm shift in a number of companies, especially healthcare. "Internet-of-Things" is a time period that can then be classified as "an umbrella key-phrase to cowl numerous elements associated with the extension of the Internet and the Web into the bodily realm, by using the good-sized deployment of spatially dispensed devices with embedded identification, sensing and/or actuation capabilities, to allow a whole new elegance of applications and services" [7]. Due to the extreme evolution of industrial verbal and non - verbal protocols primarily designed for IoT devices, such as NB-IoT, Lora Wan, or Sioux, such services will grow and grow. Meanwhile, rapid innovations in IoT communication infrastructure, including 3GPP fashionable (5G IoT), are ideally equipped to deliver low-power, low-data-price, and diverse coverage cellular connections to numerous forms of IoT devices [8]. The adoption of energy scientific gadgets (e.g., blood pressure sensors, glucose units, temperature monitoring, comparison with standard measurements, and so on.) has expanded.) and wearable sensors (to diploma e.g. ECG, accelerometer, SPo2, Heart charge, and so on.), with functions focusing on low energy, small duration, portability and clean to place on and use. Wearable sensors have expanded in the form of cosmetics (e.g., bands, jeweler), clever textiles, body implants, and frame insertions across time (e.g. Insulin pumps, pacemakers). And with breakthroughs in smart technologies, improvements in the shape of clever Doug, clever garb, or e-material, which are thought up of sees an opportunity fabric that is bonded to or woven together, have been made. Outstanding advances in close to zero and bioelectronics, nanotechnology, and materials have contributed to the development of implantable instruments and diagnostic applications for concise overview and recording.

Countless heartbreaking incidents have now been resolved in the manner of this development, which would include sensor scale, battery life, and the development of stretchable and body virtual gadgets that can incessantly and unobtrusively measure social commentary and medical and biological clinical signs without any maximum to the man or woman's ever other d Wi-Fi transceivers modalities, including Bluetooth, Zig bee, infrared, radio-frequency recognition (RFID), Wi-Fi, and reasonably close conversation (NFC) communication, are also used to connect clothing technology. Smart watches with that kind of technologies can communicate to astonishing smart gadgets (such as a telephone) to provide much further forecasting and supervision for optimal nutrition [9].

C. The mentioned proof at the benefits of m-Health programs in phrases of nice of care and reduction of price

In-home wellness antivirus scans have progressed in current history, cover a wide variety of patient care. They strive to send more environmentally sustainable and robust healthcare options, resulting in greater quality of life and a lower price. There has been a strong hit in the made on the basis of m-Health mobile phone packages focusing on a variety of ailment three much further supervision and willpower, assisting patients help regulate their chronic illnesses that permitting adult education. It is in country's best interests to be energized through contaminating avoidance, health awareness, and adaptive energy of mind [5]. However according [12], an approximated 7.1 million patients were directly linked to health surveillance equipment in 2016, resulting in a £7 trillion (over five years) savings for the NHS as a result of lower bed blockading and need-much-less consultations. Due to the above mentioned obvious benefits of clinical decision support, it gives patients peace and quiet that their conditions (e.g., heart rate, body temperature, SPo2 stages, and sleep quality) are already being monitored, and health issues and associated symptoms can be triggered to alert their own medical professionals [12 In instance, one survey concluded that the present surveillance of persons with congestive heart heart failure resulted in lower hospitalized expenses and accelerated mortality [14]. A meta-analysis of publications on the usefulness of m-Health interventions for diabetic found that, on average, over the time of a year, m-Health advanced recording glycemetic control (HbA1c) in comparison to the traditional care by much more than zero. For people with diabetes, it would be as great as 8%, while for t1dm, it's as low as 0%. For anyone with type one diabetic, the same or more as 3% [11]. Section III identifies the primary demanding situation's and destiny guidelines in growing successful IoT in-home healthy-ness tracking structures that would scale up and result in a fulfillment deployment in country wide healthcare services. Section IV concludes the paper with a summary.

II. CURRENT ADVANCES IN IOT TECHNOLOGIES AND SERVICES FOR IN-HOME HEALTH MONITORING APPLICATIONS

Among the most major boosters of in-home health tracking sensor form is the Internet of Things. The building industry blocks of IoT in-home intrusion prevention architecture are depicted in Fig. 1. The meaningful modules of such architectures, along with their interactions, are portrayed in Table 1. Different modules will be included in the computer's cloud hub (storage server, character-istic extraction module and choice manual tool). The patient hub is in responsibility of connections with the medical scribe, silks and sensors, and also the conveyance of the affected person's primary indicators and signals to the receiver of the treatment regimen. Healthcare professional portal bundles facilitate patient therapy by allowing collaboration with scientific staff. The communication between many of the clouds hub and other persons useful tool with the affected woman's and healthcare expert's hub in Asic in-home healthcare monitoring is done across an interoperable and storage Services Connectivity API (e.G. Based mostly on RESTful internet services). There has been a major upsurge of such apps for long term illness self-management (e.g., diabetics and cancer), prescription commitment (Smart tablets), assistive lifestyle (Parkinson and mild cognitive conditions), amongst other uses. In the table below, I provide one synopsis of a selection of such uses. It contains a brief summary of the structures, their merits, and a list of the sensors utilized in the detection systems [53] - [62].As shown in Fig. 2, the design of IoT-based completely in-domestic healthcare monitoring generally comprises five regulatory authority IoT generations. The three subs, which are influenced by all those technology innovators, represent modern developments in IoT generating and offering for in-home fitness surveillance systems.

A. M-Health and assistive sensors

All of those are sensitive and non-sensors that are used to identify biomedical symptoms and variations in the living arrangement. Biomedical indications are determined by a person's lifestyle, as well as social, intellectual, and intellectual contexts (e.g., Diabetes, COPD, Cancer and highbrow disorder). Some factors, such as blood glucose, blood stress, temperature, ECG, and weight, must be managed in such scientific conditions. As

both a response, there is a desire for sensors to monitor these circumstances. For the living arrangement, it is look at what people want in the assistive habitation period, such as personal alarms, sensor mat, virtual video cameras, and so on. To allow com-medications of the measured sign with the surrounding worldwide, those sensors are associated with Wi-Fi communications modalities which include, RFID, NFC, Bluetooth and BLE, Wii and Zig bee.

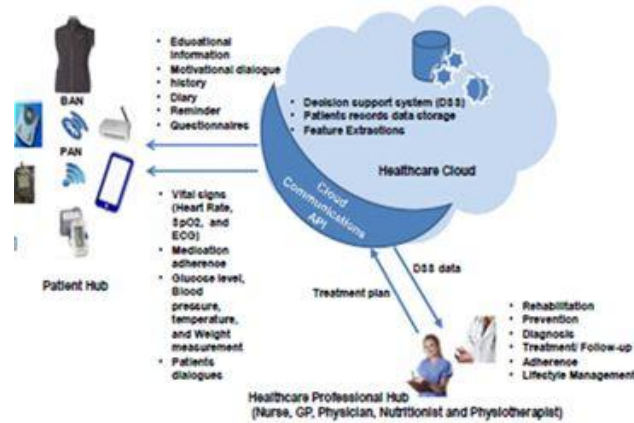

Fig. 1. IoT based in-home remote monitoring system architecture

Figure-1

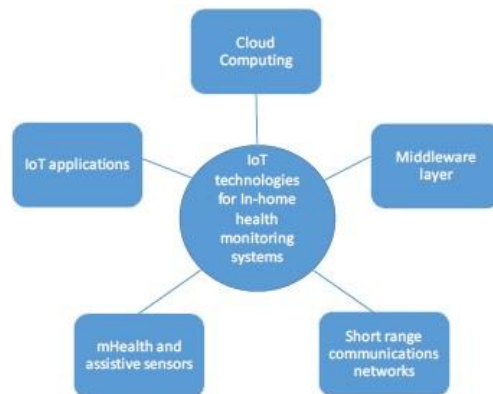











Fig. 2. Key technologies for IoT based In-home health monitoring systems

IOT In-home application	Sensor Type	Description	Advantages	Photo
Welcome system-COPD with comorbidities integral care management system[14,39]	Spirometer, Glucose meter, BP, weight Scale, temperature sensors and wearable vest that include heart care , ECG, ETT, accelerometer and spo2 Sensors	Wearable and cloud computing to support integrated care management for COPD patients with comorbidities	To manage the COPD condition to give early detection of COPD complications(Potentially reducing hospitalizations and the preventions and mitigation of comorbidities (Hear failure , Diabetes, Anxiety and Depression)	
Smart Pill [53]	Ultra-thin HPMC capsule with and embedded ingestible wireless sensor, powered by stomach fluid	The sensor get activated when it comes into contact with stomach fluid to detect when the pill has been taken	For painless drug delivery, injectable drugs are converted into pill , the pill positions itself to inject the drug into the intestinal wall	
Asthma monitoring [54]	Breath sensor that measures levels of nitrogen monoxide ,audio recorder, mobile APP connectivity	It is made for monitoring asthma patients and collecting data for a period of the time in the patient's own home, by ambulatory recording (no Donald Wheeze, cough)	It is useful for doctor in their design of treatment plans of asthma by knowing the respiratory function of the patients over a period of time	
Skin Cancer Detection [55]	Ultraviolet detector /sensor	It is a wearable warning device that measures UV radiation level which is the most important environment factor in developing skin cancer.	The sensor can accurately measure the UV dosage absorbed by skin, distinguishing between UVA and UVB (which cause different types of damage) and gives early warning.	
Breast Cancer Detection [56]	Sports Bra-like material encased with sensitive heat sensors	It detects small changes in temperature in breast tissue. The self-checking bra is wom close to the body. The collected data are sent by IOT and analyzed by AI, results of which are then sent to the users smart phone	This smart bra can detect abnormalities with a 90% and higher accuracy rating in women of old ages.	
Cancer biomarker in urine detection [57]	Chip based sensor with an integrated laser	It detects very low levels of a cancer protein biomarker in a unique sample	This new technology is more sensitive than other designs and could lead to non-invasive and inexpensive ways to detect molecules that indicate the presence or progression of a disease	
Closed loop insulin delivery [58]	Blood glucose sensor, electronic insulin pump	It acts like an artificial pancreas; this closed loop system automatically delivers insulin to people with type 1 diabetes, in response to the glucose levels of people with Type 1 diabetes. It allows users to customize their diabetes treatment.	It automatically adjusts the users insulin levels at a basal rate, to keep blood sugar levels steady	

Coagulation tester [59]	Highly sensitive optical sensor	It measures that user's ability to clot, and how long it takes to clot. it help the user to self-assess the risk of excessive bleeding or developing clots (thrombosis) somewhere in the blood vessels.	Early detection helps save lives because whenever such clots form, they can travel through the blood stream to the heart, longs or brain. This can cause a heart attack, stroke, or even death	
Depression Monitoring [60]	Smartphone "Acceleration", sensor, GPS sensor, microphone, wearable, inertial sensor-accelerometer, gyroscope, sweat sensor	Wearable devices and smartphone are used together as multi-model approach to assess and monitor sleep for patients who are in depressive, anxiety, or psychotic disorders	It promotes long term adherence , enabling monitoring for adaptive and personalized systems, which helps to predict risk/relapse sleep problems and depression	
Parkinson's and Alzheimer's disease monitoring [61]	Behavior's sensors , RGB-D Camera (For gait analysis), wearable pressure sensor and microphone (For verbal monitoring)	This system measures and assesses bradykinesia and freezing of gait, mainly those symptoms that can pick up by inertial sensors, and sensitive wearable sensors.	It is a self-care strategy that can help patients suffering from Parkinson's. Doctors will receive a filler views of the behavior disorientation hence better treatment plan could be made	

EXAMPLES OF M-HEALTH AND ASSISTED LIVING SENSORS AND APPLICATIONS
Table No.1

Table 1 contains a list of devices connected that also are deployed in either a range of ailments disease prevention, adhering, and eased ageing schemes. The overwhelming majority of these sensor and instrumentation is fella, with records networking regulations in order to manage portability and packet connectivity. Electronic Healthcare Data (PHD) ISO/IEEE 11073 and oneM2M are 2 cases of such standards

B. Shortest-range communication networks

Wireless sensor networks (WSN) and Personal Area Networks (PAN) are used to represent short-range communications systems throughout this dialogue: WSN stands for Wireless Sensor Network, and it is a network formed up of unique of clearly defined instruments that could expose special fitness situations and/or assisted living variables. It may be referred to as Wireless Personal Area Network in the case of equipment that will only be worn by persons (WBAN). PAN is a network that allows instruments and data using wireless networks, such as telephones, to talk using particular telecom such as Bluetooth, BLE, WI, and other protocols. It is related to the fact that alterations are inevitability. BLE, for example, is sufficient to provide records for sensory indicators which include SPo2 sign over a bad online connection of 0. 5 Hz [16].Deny the reality that the speed of 25 lead ECG can exceed 500 Hz, Wi-Fi

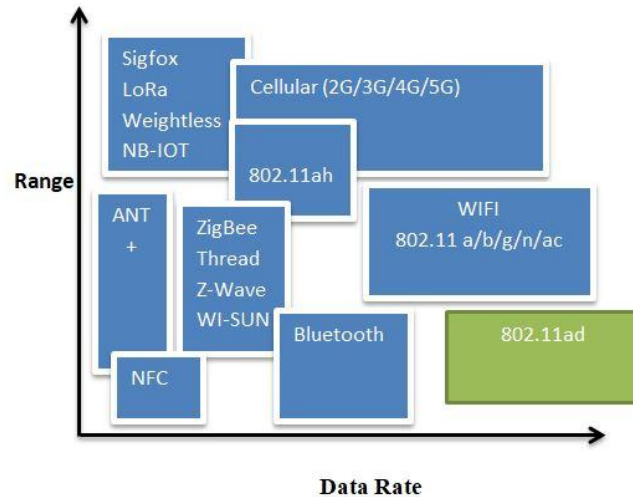

Figure No.3 IOT protocols in term of range and data rate

Figure-3

Latest procedures, and even as NB-IoT, LoraWan, and Sigfox, are specifically intended for IoT devices, They're built in using low significant networking (LPWANs), which enable the connectivity of a massive number of devices at a low bit rate, power efficiency, and low coffee cost. The IEEE 802.15.6, in particular, is a wi-fi framed region community (WBAN) well-known advanced for improved health monitor, which facilitate information rates over time as 10Mbps, a range of 1-2 feet, low strength, and high Reliability. [19][19]. Its most significant advancements in IoT communications network are the current 3GPP ultra-modern development of (5G IoT) to provide limited, malicious websites. And Cell phone interconnections different IoT devices providing wide-area coverage [8]. This encompasses both direct 3GPP connections and indirectly non-3GPP connections via wide band IoT (NB-IoT). Every uplink and download for NB-IoT must have a programmer of one hundred twenty kHz. A diverse bridge incorporating a decreased massive-region network (LPWAN) and mobile networks via relay individual system (UE) seem to just be a possible desire to handle non-3GPP, 5G IoT connectivity [8].

C. Middle-ware Layer

It's a class of business software that helps connect to data streams from sensor devices on one end to cloud services but at the other.

The evidenced - based of the client machine with that is it creates the overview of the underlying sensors. The new system collects signal and transmit that to the cloud infrastructure, acting as a gateway between the clouds and fully featured. The link layer is widely adopted in a consistent system that helps communications with any sensing unit or the run like any code with little settings [20]. A son controller enhances project implementation with solutions of different between smart systems as well as an arithmetic logic unit [21]. In this other meaning, midstream is a virtualization technology that encapsulates some of the infrastructure for mobile terminals and tools. By developing and supplying premium services with software predicated on the composite of available device attributes, gateway solutions offer actual smashups [21]. The following must be considered characteristics for a middleware layer:

- It has to manual interoperability to resource multiple heterogeneous devices.
- It should offer an excessive-stage API to access the offerings that summary the underlying gadgets.

The available studies contain several of the research initiatives aimed at creating middleware solutions for IoT packages of various nodes [23]. The basic purpose of most contemporary middleware frameworks and research projects became to include a uniform form layer framework to support the critical needs of the many fields. Most of these efforts have now been appreciated for their combining with existing middleware. MOs den [24], for examples, is a middleware tool that captures telemetry of outside sensors along with internal detectors on smart phones and uploads it to the GSN (Global Sensor Network) gateway UBIWARE [25], provides an operative software middleware for detecting and monitoring in certain equipment as inputs, then integrating them as supplements to financial projections. It's developed on the JADE (Java Agent Development Framework). It shows the help as a Sql software system agent that monitors the aid and supports interchange with globally unique elements. Each agent has a behavioral model that defines the agent's functionality and is described in the Scientific Agent Programming Language, a UBIWARE exact principle entirely semantic (SAPL). UBIWARE

middleware is targeted greater on systems that might guide a couple of marketers to manipulate property. HYDRA [26]], which has now been merged into Link smart, is a ship concept entirely middleware. It is advantageously aid-aware, and therefore it better hosts its Terminal Emulator problems on more advanced robots classified as Hydra-enabled devices. The Hydra population is attached to the constrained less expensive gadget via a proxy that web applications source connections to obtain access to a tool. Each Wraith instrument provides with spoken sensing and can act as a portal by hosting http proxy. Many EU projects do use HYDRA pick, including M actually [27], inCASA [28], ebbits [29], MASSIF [30], SEEM Pubs [31], and SEAM4US [32]. HYDRA's openness, on the other contrary, is constrained on Health Device Profile (HDP) devices [33]. Secondly, HYDRA doesn't quite consider the fact of REST allows customization.

My health assistant [49] is a tournament text Middleware design. It was developed to save time & water while obtaining and consolidating data from a wide range of BAN monitor and secondary sensor systems. Open IoT middleware [34], an EU FP7 project, intends to allow IoT construction based solely on application software computing delivery edition. It sticks to HTML principles and delivers a Restful net service asset basis. So, it employs W3C Semantic Communication Infrastructure (SSN) for sensors description and IETF Application layer (Routing Protocol Protocol) for M2M communication. In order to ascertain a formal review of specific absorption [19][50] [51] [65].

A normal impacted by hub platform might well be isolated into two layers: software layer, software layer, and sensors layer, as can be seen in Fig. Four, which is driven either by Web-of-Things (WoT) creative and foresightful. The web server will use the intermediary piece to gather data from sensor layer to transfer that to the cloud. The proposed inter-mediate layer is mostly based on Rest online services, which allows the WoT architecture in the clouds to meet the computational cost that occurs with implementing new front capabilities. This framework treats all ensure new as assets it provides Unified Re-source Signifiers (URIs) for dealing to them over HTTPs, facilitating the application of broadly agreed and verifiable criteria. Those are skills training for any cloud computing for IoT-based in-home fitness remotely communication networks, as per the criteria above:

- Hetero-genetic: To discuss different Wi-Fi protocols, smart sensors, and Applications, the format must be changeable.
- Flexibility: The general practitioner program of an in-home gym long monitoring system must work softly in display specific care attributes all while helping the surgeon's movement at home (e.g., Accomplishing a few smooth domestic sports like gar-dining).
- Inter-operability: It must be surface and synchronized the captured health information with the cloud.
- Adaptableness: To dealing with changes in sensor arrangement, the structure should really be creative and innovative.
- Consumer Experience: The much more essential quality standards of the client component of in-home health far off tracking bundles are accuracy and reliability. This is in addition to measures to match the injured man or woman airport's strong accessible and budget.
- Safety: Sufficient protection and secrecy are essential as standardized protocols in any e-fitness platform to steer unique, authenticity, and affordability

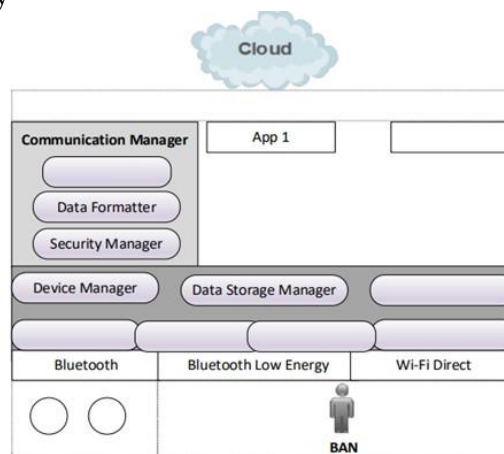

Fig. 4. Middleware software architecture design.

Figure-4

D. Cloud computing

Cloud computing has been used in any other sub-gadget of an in-home fitness the furthest detachment. It is a blog fully computing platform that is used to supply; data management that will save compiled input from data Sensor hubs and sensors, workstations to pathway and quantify the data obtained, and practical systems that have used the conducted a study to only provide warning bells and simply accept to enable the availability of, for example – physicians for hospital hospitals [63]. There have been many proposed IoT cloud computing systems, and can be used as Cloud providers (IaaS), Platform as a Service (PaaS), or Software as a Service (SaaS). Table Better approach the most commonly accepted IoT systems along with their key trends. Communication, security, data layout assist, programming language instruction, and data analytics are included on the package [35]. When considering cloud computing, various factors must be taken into considerations, including pricing, availability, deployment type, and system architecture. Figure 1 illustrates an image of cloud technology that is need for an IoT-enabled entirely in-home touch interface. These capabilities may have only been available out of one of the Table II platforms, such as Amazon Web Services. The storage server, the characteristic extraction modules, and the selecting manual mechanism both are part of these cloud providers (DSS). These module deal with hospital data provided either by surrender users' resource. Computing resources are often developed with three key goals in mind: freedom, scalability, and interoperability [15]. The integration of cloud health record handling regulations, including such H-7 FHIR, to an ongoing interaction across organizations facilitates communication. The fact the new assets can indeed be given to the model sans having to change the clouds connectivity API destinations facilitates scalability. The detailed integrated maintains the surgeon's statistics, bio-indicators, and bio parameters downloaded from the patient hub, as well as health related statistics derived from the patient's evaluation by health workers. The raw signals arriving from the harmed man or woman hub are recovered from the garage by a function extraction module (e.g., ECG). For employment in the screening process, its module extracts a range of high capabilities. The decision guide device (DSS) is designed based totally on semantic net technology (e.g. RDF, OWL) and dynamic regulations to decorate the inference method. Some prevalent capabilities provided by way of both the decision help methodology involve creating alerts, responding positively, and supplying alarms, alerts, and notifications on the level of patients' fitness relying on the patients' extract capabilities.

E. IoT Apps:

IoT applications serve as an avenue between the client and the objects. They enable device-to-device, living organism, and life form communication. They should be capable of providing information easily, just something, and recommend remedies. Many publications analyzed in detail the functionalities of such solutions for Internet - of - things in-home wellness far-flung surveillance for continual disease prevention For illustrate, the authors of [52] did a comprehensive overview of the evidence to identify the skills of cell diabetes systems, whereas the scientists of [33] conducted a review of the literature to identify the capacities of COPD self-management initiatives. Both projects were completely dedicated to assessing the precept capacities of IoT man or woman programs. The capabilities described in here are examples in chronic cerebra force of will programs:

- Capacity: This is considered device-to-device interaction, and it permits a smartphone's application software application and sensors to talk. Measurements of glucose levels gradient with in diabetics
- Surveys: This is a tool to human interplay; it permits the gathering of subjective reputation (e.g., Temper) of the sufferers thru talk or verified questionnaires.
- Enlightening: This is a resource for professional communication; it permits you to just provide appropriate education based solely on the objectives of their patients (e.g., Nutrition information training).
- Antiquity: This is a mechanism for social interaction; it provides information from the data received over time.
- Record and prompt: This is a problem for self-engagement; it educates sufferers about both the timetable on their treatment regimen.
- Communications: This is electrical type of communication. E.G. Encouraging naturopathic doctors and patients through “notable
- Medicine Prescribe: This is a resource for professional engagement; it presents, for ex, a list of medications, regular timing, and strength.

TABLE II
IoT CLOUD COMPUTING INDUSTRIAL PLATFORMS

IoT platform	Common communication protocols (HTTP, CoAP, MQTT, etc.)	Security (authentication, authorization and encryption)	Data Format Supported	(platforms have strong analytic capabilities)	Programming Languages Support
Amazon Web Services (AWS)	HTTP, MQTT, WebSocket	Encryption Authentication Authorization	JSON	Yes	C, Java, NodeJS, Javascript, Python, Arduino, Android, iOS
Google IoT Platform	HTTP, MQTT	Authentication	JSON	Yes	Java, .NET, Node.js, php, Python, Ruby
IBM Watson	HTTP, MQTT, REST API	Authentication Authorization	JSON, CSV	Yes	C#, C, Python, Java, NodeJS
Microsoft Azure	HTTPS, MQTT, WebSocket, AMQP	Encryption Authentication Authorization	JSON	Yes	C, .NET, Java, NodeJS, Ruby, Android, iOS
Kaa	MQTT	Encryption	REST API, JSON	Yes, but not real time analytics	Java, C, C++
Oracle IoT	HTTP, MQTT, CoAP, WebSocket, XMPP, and AMQP	Authentication Authorization	REST API, CSV	Yes, but not machine learning	C, Java, Javascript, Android, iOS

III. CHALLENGES, RECOMMENDATIONS AND FUTURE DIRECTIONS OF IOT BASED IN-HOME HEALTH MONITORING SYSTEMS

As IoT technologies get more available and familiar to physicians and nurses, new challenges are available and continue to be driven by investment capital and research funding by both the government and private sectors. The IoT for e-Health looks bright; new features are being integrated into businesses and services. This means of technological advances in ability to trace in hardware, ubiquitous connectivity, and advanced analytics offered by data center statistics technology. E-Health is considered as a daunting challenge Horizon 2020's European Digital Agenda [34]. With the use of e-Health and m-Health, it is potential to save over 100 billion euros in health costs. The market value of all smart wearable's that monitor fitness or well globally is allowed to increase \$12 billion USD by 2022 [35]. Recently, a variety of Technology e-Health solutions have arisen, varying from ambient aided staying for infection reduction to medical emergency offering for escape. In the near future, a highly integrated in-home wearable fitness system with optimized acute care will indeed be available. While sleep disorder treatment and therapy is not each event, a huge array of IoT sensors must have been in place to facilitate holistic geological and physiological track. IoT performs a critical position in allowing data links from a couple of locations for virtual session in destiny Tele Health. Based on this, a health practitioner and sufferers' session can be equipped with not really lab outcomes, however additionally with the facts of statistics remotely measured while sufferers at home the use of some wearable's and in-domestic far off affected person tracking programs. Using the available statistics and aided via desire useful resource systems that still have get right of access to large information for specific people, the health practitioner could make a higher analysis and offer customized remedy. That very disrupt demographic must have a transformational influence on international level of access, particularly in the area of lowering hospital waste and enhancing diagnosing speed [36]. The consequences of this dangerous situation, — especially in significant IoT-based absolutely totally several other travel time flung surveillances in the health sector, that justifies facts communication but also switch among these inserted gadgets, are tricky, and they give rise to the many problematic conditions and design research that will be addressed in the future growth of such processes. Totally in-home fitness system based on internet of Things that term "remote monitoring" consists of a network of structures, systems, and sensor that are linked by statistical statistics. It's a solution who allows users to manage statistics and control devices virtually

based on your needs the quantity of solutions (QoS) supplied by control panels, and also the satisfaction of end-user demands, affects these characteristics for IoT applications. The IoT challenges and issues are provided in this chapter by connecting them to IP QoS and planning on giving objectives. There seem to be a variety of amazing attributes which can be used to quantify QoS, and a range of viable Approaches for interpreting QoS metrics in distributed programming already have been suggested. This type of model is ISO/IEC 25010 [37] high-quality version ISO/IEC (2010). Sensible steadiness, common ongoing success, compatibility/interoperability, usability, security, protection, modifiability, and adaptability were amongst the QoS methods described Resilience, average national throughput, useful proportion, safety, reliability, and robustness were identified as QoS criteria in IoT architectures by the paintings in [38]. This report analyzes the subsequent advice and future guidelines that need to be treated in the future adoption of Iot solely based truly in-home exercise far away tracking relying on this QoS list:

A. Performance, Well-designed stability and Trustworthiness

These QoS indications are offered later part and are suitable to all thread of the IoT form, from a woman's home and health cloud storage. For cloud products, it's considerably more important to ensure that perhaps the cloud computing may handle the maximum expected number of clients without rejecting calls, as well as to discover probable server-side overall quality constraints. This will mean monitoring the reminiscence intake to identify any issues with undesired memory leaking or badly crafted statistical caches.

This comprises the fundamental actual quality, practical robustness, and trustworthiness of the WBAN and WPAN networking in elements of wireless interference from the existence of start with a simple data modality for the individual's household savings (e.g., Wi-Fi, Zig-Bee or BLE that lease the 2.4 GHz ISM band). In opposed to other techniques operate on a same frequency spectrum, Wi-Fi making use of fine mines and energy, resulting in more interference. Additionally, using such a large data rate for Wi-Fi transmission reduces bandwidth available for these other electronics communications. Wireless interference might occur in irregular or unpredictable access, delays in connectivity / record flipping, slow community speed, and poor picture quality. Many investigations have been performed to identify the cause and impact of coexist concerns in WBAN (IEEE 802.15.6), Wi-Fi, BLE, and IEEE 802.15. [64]. every other regular overall output measurement that can decrease regular dominant culture and reasonable balance has based on energy Self-Managed. For instance, at the individual away section, semi monitoring perceptions that wearable's must be operational for a longer length of time that might range from hours to days based on the scientific circumstance. This approach drains the power, demanding recharging it, inevitably, deleting the pro method based. Signs and symptoms thought to be caused by Wi-Fi interfering are caused by a low charge cycle. QoS characteristics such as effectiveness and useful stability are critical. Low and overall effectiveness and favorable balances system result in low adoption and appeal among quit-customers [39]. Such indicators are just something engineers, testers, inspectors, and app developers wish to deal with and treat. It should also subsequently lead to a significant use of such methods and an acceleration of such services with in health industry, due to the higher wellbeing and occasional value, as identified in the contract.

B. Safety, Confidentiality. Principles and Rule

Fixing data leakage in IoT design and development is critical for developing take-off as realistic with the use of Rid actually systems in the healthcare industry. To eliminate associated risks and assaults, maintain horrors, security procedures should always be built (privacy with the valuable commodity of layout [40]) at each layer and every piece of the Derived from the work. Many residential and business devices are all being built no made to ensure to verify the safety and horrors aspects [41]. Manufacturers seek to make sure that the "themes" that make internet of Things and the systems to which they interface are safe; that the senses, devices, hubs, and IoT services can be trusted and clients, and that underlying identify, protections, and privations are protected and preserved. The largely affected on inherent safety protocols (e.g. Encryption) from the inside devices and connectors of Wi-Fi connections' synthesized hardware and software business applications additives in several in-home education's IoT based obviously a long time flung tracking program. Historically, the programmers of represent the overall for these sorts of monitors and equipment's base their models on anonymity, developing and renting the necessary protections in conditions of authentication, identity management, and encryption for all recorded and mobile recordings. That most of these packages are associated with local hospital telephony that have its non-public security mechanisms and privacy measures in place, or aren't up to speed with today's requirements set and techniques. Privacy security mechanisms choose to help cope in detecting who now has sole rights to and modification of documents. IoT users are given that their research methodology, storage, and use are done in a way that benefits them and does not compromise human rights. Several suggestions and guidelines, as well the Health Insurance Portability and Accountability Act (HIPAA) [42] and the EU General Data Protection

Regulation (GDPR), have already covered privacy in establishing Computing.) [40]. Nonetheless, it's crucial to mind the additional usage of the data gathered by long-term home IoT monitoring. Buyers who help with either the establishment of these methods may also agree that their information will be used for the full goals of remote monitoring and no anymore for desired outcomes, such as the use of electric data in system design (Big data analytics) [44]. The advancement of IoT has often stimulated emerging technologies, and it has also culminated in an increase in important moral and political misdeeds [48]. Thoroughly definitely IoT-based computers lead to a deeper understanding of both the ethical as criminal domains, as well as the historical milieu. This social license for investigation is subject to the provisions: Solidarity, mid service, with public property [43]. Have enough of it in with the majority of persons in the talk who question your received knowledge for criterion to be met. The target of improved NHS service reading is to keep up with the demands of – anti and proper conveyance for the majority of users. Conversely, the use of data gathered through (e.g., such IoT packages) infringes on such commitments with interaction [44]. One of the reasons for this low adoption of Internet of things among give-up buyers has been revealed to be an absence for data security, horrors, and safeguarding in IoT devices. As a reason, this issue must be calculated in order to advance overall comprehension of the use of IoT systems and devices.

C. Inter-operability

IoT interoperable is characterized as “the power of institutions to speak with and share services one another” [45]. Tool integration, networking interoperability, syntactic interoperability, semantic interoperability, and program interoperability are all components that make up IoT interoperability [46]. Interoperability plays a crucial role in IoT development, primarily in the healthcare industry. IoT-based full in-home health monitoring from afar has many IoT sensors, gadgets, applications, and services, requires large volumes of data communication in flat bed. Hence, interoperability must be considered thru IoT developers and medical tool manufacturers while developing IoT primarily based totally a long way off tracking systems. Many new medicines, such as infrared thermometers output pedometers, use the ISO/IEEE 11073 Personal Health Data (PHD) portability requirements in their storing verbal interchange, enabling IoT software developers to have them at the conduct of the study. Higher IoT devices, on the other contrary, depend only on the oneM2M telephone survey strategy. As a result, a few measures must be taken to allow PHD and oneM2M to speak with each internal environmental Sensor node [47].

Although many IoT requirements and structures were advanced and helped in advancing IoT interoperability troubles, there are although some open studies challenges to be solved [45]:

- To reputation on circulate-layer flow-platform interoperability than virtually the sensor/device and network layer interoperability using semantic internet technology and internetworking APIs.
- The interoperability should be made possible irrespective of the underlying era (e.g. Non IoT devices).
- Interoperability sorting out wishes to be automatic in vicinity of the modern-day complex approach of interoperability sorting out that includes all of the stakeholders of era vendors, developers and stop-customers that can affect proper interoperability trying out and in lots of times can also have an effect on security mechanisms trying out.
- Leveraging public RESTAPI to obtain sufficient access to information instead than private RESTAPI, which makes pooling data across technologies difficult. Even if most IoT structures supply public RESTAPI, other IoT employ proprietary RESTAPI.
- Construction of a comprehensive IoT gateway platform with calculates a variety of standards web services that smartphone makers can choose between (e.g., CoAP for limited devices). They can also be free interoperability gateway solution for promoting device-to-device (D2D) connections.

With the greater sophistication of networked IoT systems in technology, related services, knowledge and Accessible, human errors, and bypass-border governance frameworks, interoperability issues become extremely tough to deal with [66]. ISO/IEC 21823-1:2019(E) [67] is a cutting-edge Interchange for IoT structures model that solves a problem and create a better insight of interoperability with today's modern IoT systems and the different aspects that affect it.

D. Scal-ability

In-home health continuous management requires extensibility, which is an important aspect of IoT destiny management. It speaks to the chances of introducing new features, sensors, devices, and packages to the device without impacting its system results. While legal rules stipulate storage, computation, communications, and several other transporting needs, scale is a critical component of IoT's capacity to store a wide range of applications, endpoints, and solutions [68][69]. Both the user device and optimization algorithms exhibit adaptability. They offer greater support for accelerating IoT devices, along with new sensors, connectors,

additional issuer's specifications. This path has led to the formation of a unified IoT framework that meets policy objectives by incorporating cutting-edge innovation.

IV. CONCLUSION

The IoT generation has led to the development of the realities of its premise a decade ago, with increasingly more effective implementation at smart city and smart home responsibilities all over the country. However, the beginnings of E-Health may even be linked back to the invention of recent digitization activity over a long period, stretching from the upgrading of telemedicine to the providing of teleconference. By tapping at the ubiquitous computing electricity and sensing capability, IoT fueled e-Health programs to beautify and foster better diagnostics, session, drug control, and preventive recommendation. This one has been identified that IoT plays a key role in collecting and processing information to the clients as strength training recognition feedback, in the healthcare agency firm, or to a physician and far-flung clinical scientific docs for a more complete picture of the customers' official and unofficial chronic illnesses and livelihood opportunities. It is planned that additional tasks will arise accompanying this course, catching up in time with the substantial funding benefits presented by the use of several countries all over the world. It is indeed clear that in recent decades, both acquisitions in the e-Health large corporation enterprise organization and continue of American IoT and e-Health organizations have snowballed.

With the help of IoT generating, which brings value inside the cost, new ideas are exploited; accepted scientific routes and approaches are made more potent. Concepts prototypes can be refined and implemented into everyday e-Health operations in the near future, eventually becoming an essential element of our healthcare routines. Despite all the blessings of healthcare systems, and several open issues live on the (universal performance, reliability, practical balance), (safety, privacy, prison and ethics), (compatibility, interoperability) and (maintainability, scalability) amongst others.

AI and Big Data will be important in creating IoT in national health care in the future. When these systems are integrated to existing data across multiple people, it is possible to provide a more plan for the patient for them. For instance, since more people with asthma becomes joined via apps and artificial glucose sensors that systems receive interstitial hyperglycemia, the quantity of data on cognitive performance will soar. The practitioner will not merely be interested in looking at long management via HbA1c, but it also glucose levels couple of seconds. AI will empower apps that do provide access level for those with degenerative illnesses, such as changes in their prescription schedules and lifestyle standards. A vital aim is really to act as a bridge between the IoT technologies link and the intellectual network. The advent of IoT-based integrated healthcare supervision is moving at a rapid rate these days. However, it is not commonly noted within in the scientific hospitals; scientific enterprises, is from the other hand, are unwilling to support the some distance out imaging technology for a range of factors. How will a coverage organizations organization, for one, pay of far analysis fee? (E.g in USA)? We have keep in mind that Wireless completely faraway tracking isn't always the best option. Try replacing THIS Spot with Both the Ssn OF Their PAPER Recognition (DOUBLE-CLICK HERE TO EDIT) Modern facial expression research, and is more of an assisting invention that could augment new therapeutic procedures. As new m-Health events and packages grow and become a reality as society, illness, and eras evolve, both well key conclusions may likely to be true. In order for new equipment innovation to test from, exploring the best must retain reporting on the rewards, dangerous situations, and education findings of IoT in-home fitness surveillance systems adoption. This study outlines the demands, technology advances, worrying conditions, advice, and open issues for IoT-based in-home fitness wearable sensors.

REFERENCES

- [1]. WHO, mhealth: **New Horizon for Health Through Mobile Technologies** (Global Observatory for e-Health Services), vol. 3. Geneva, Switzerland: WHO, 2011.
- [2]. WHO, WHO guideline recommendations on digital interventions for health system, 2019, ISBN: 978-92-4-155050-5 [Online]. Available: <https://www.who.int/reproductivehealth/publications/digital-interventions-health-system-strengthening/en/>.
- [3]. R. S. H. Istepanian, E. Jovanov, and Y. T. Zhang, "Guest editorial introduction to the special section on m-health: Beyond seamless mobility for global wireless healthcare connectivity," *IEEE Trans. Inf. Technol. Biomed.*, vol. 8, no. 4, pp. 405–412, Dec 2004.
- [4]. WHO, "Key facts: **Mental health of older adults**," 2017. [Online]. Available: <https://www.who.int/news-room/fact-sheets/detail/mental-health-of-older-adults>
- [5]. Market Watch, 'mHealth Market 2019: Industry Analysis, Size, Share, Growth by 2025 - **Global Market insights**', 2019.[Online]. Available: <https://www.marketwatch.com/press-release/mhealth-market-2019-industry-analysis-size-share-growth-by-2025---global-market-insights-2019-07-29>.
- [6]. **NHS Long Term Plan**, 2019, Available: <https://www.longtermplan.nhs.uk/>.
- [7]. D. Miorandi, S. Sicari, F. De Pellegrini, I. Chlamtac, '**Internet of things**: Vision, applications and research challenges' *Ad Hoc Networks*, Volume 10, Issue 7, September 2012, Pages 1497-1516.
- [8]. A. Froytlog et al., "**Ultra-Low Power Wake-up Radio for 5G IoT**," in *IEEE Communications Magazine*, vol. 57, no. 3, pp. 111-117, March 2019.

- [9]. K. Guk, G. Han, J. Lim, K. Jeong, T. Kang, E. K. Lim & J. Jung, (2019). **Evolution of Wearable Devices with Real-Time Disease Monitoring for Personalized Healthcare**. *Nanomaterials* (Basel, Switzerland), 9(6), 813. doi:10.3390/nano9060813.
- [10]. A. Lee & K. Lee, 'The Internet of Things (IoT): Applications, investments, and challenges for enterprises', *Business Horizons*, Volume 58, Issue 4, July–August 2015, Pages 431–440.
- [11]. S. Kitsiou, G. Paré, M. Jaana, B. Gerber, 'Effectiveness of mHealth interventions for patients with diabetes: An overview of systematic reviews'. *PLoS One*. 2017;12(3):e0173160. Published 2017 Mar 1. doi:10.1371/journal.pone.0173160].
- [12]. 'The Rise of Remote Patient Monitoring', May 2019, [Online], Available: <https://thejournalofmhealth.com/the-rise-of-remote-patient-monitoring/>.
- [13]. A. Bui, G. Fonarow, 'Home monitoring for heart failure management'. *Journal of the American College of Cardiology* 2012;59(2):97–104. doi:10.1016/j.jacc.2011.09.044.
- [14]. I. Chouvarda, N. Philip, P. Natsiavas, et. al, 'WELCOME – Innovative Integrated Care platform using Wearable Sensing and Smart Cloud Computing for COPD patients with Comorbidities', *IEEE Engineering in medicine and biology society*. August 2014. S. Turner, "New directions in communications," *IEEE J. Sel. Areas Commun.*, vol. 13, no. 1, pp. 11–23, Jan. 1995.
- [15]. J. Wacker et al., "Electrical and mechanical design of a vest measuring a large set of physiological signals," 2014 4th International Conference on Wireless Mobile Communication and Healthcare - Transforming Healthcare Through Innovations in Mobile and Wireless Technologies (MOBIHEALTH), Athens, 2014, pp. 47–50.
- [16]. Postscapes . 2017. "IoT Standards and Protocols," [Online]. Available: <https://www.postscapes.com/internet-of-things-protocols/>.
- [17]. A. Saboor, R. Ahmad, W. Ahmed, A. K. Kiani, Y. L. Moullec, M. M. Alam, 'On Research Challenges in Hybrid Medium Access Control Protocols for IEEE 802.15.6 WBANs', *IEEE Sens. J.* 2018, 19, 1.
- [18]. N. Philip et al., "Design of a RESTful middleware to enable a web of medical things," 2014 4th International Conference on Wireless Mobile Communication and Healthcare - Transforming Healthcare Through Innovations in Mobile and Wireless Technologies (MOBIHEALTH), Athens, 2014, pp. 361–364.
- [19]. F. C. Delicato, P. F. Pires, and J. Katz, "Middleware Solutions for the Internet of Things," 2013. Springer Publishing Company.
- [20]. S. Bandyopadhyay, M. Sengupta, S. Maiti, and S. Dutta, "Role of Middleware for Internet of Things: A Study," *Int. J. Comput. Sci. Eng. Surv.*, vol. 2, no. 3, pp. 94–105, 2011.
- [21]. C. Perera, P. P. Jayaraman, and P. Christen, "MOSDEN : An Internet of Things Middleware for Resource Constrained Mobile Devices," in 47th Hawaii International Conference on System Sciences (HICSS). 2014.
- [22]. V. Scuturici, J. Petit, and U. De Lyon, "UbiWare : Web-based Dynamic Data & Service Management Platform for Aml," pp. 5–6.
- [23]. "HYDRA." [Online]. Available: <http://www.hydramiddleware.eu>.
- [24]. "REACTION." [Online]. Available: <http://www.reaction-project.eu>.
- [25]. "inCASA." [Online]. Available: <http://www.incasa-project.eu>.
- [26]. "ebbits." [Online]. Available: <http://www.ebbits-project.eu>.
- [27]. "MASSIF." [Online]. Available: <http://www.massif-project.eu>
- [28]. "SEEMPUBS." [Online]. Available: <http://seempubs.polito.it>.
- [29]. "SEAM4US." [Online]. Available: <http://seam4us.eu/>.
- [30]. A. J. Jara, M. A. Zamora-izquierdo, and A. F. Skarmeta, "Interconnection Framework for mHealth and Remote Monitoring Based on the Internet of Things," *IEEE JSAC*, vol. 31, no. 9, pp. 47–65, 2013.
- [31]. "OpenIoT." [Online]. Available: <http://openiot.eu/>.
- [32]. M&S Consulting . 2017. "Industrial Internet of Things Platform Comparison," [Online]. Available: <https://www.mandsconsulting.com/industrial-iiot-platform-comparison>.
- [33]. D. Sobnath, N. Philip, R. Kayyali, et. al, "Features of a COPD Patient Support Mobile Application : Review of the Literature and Analysis of Current Applications." *Journal of Medical Internet Research MHealth and UHealth* 5 (2). <https://doi.org/10.2196/mhealth.4951>
- [34]. **Shaping Europe's digital future**, POLICY, Research and Innovation in eHealth, [Online]. Available: <https://ec.europa.eu/digital-singlemarket/en/research-and-innovation-ehealth>.
- [35]. **Wearable Fitness Technology Market Report**, 2016, [Online]. Available: <https://www.marketsandmarkets.com/Market-Reports/wearable-fitness-technology-market-139869705.html>.
- [36]. M. Hassanaliheragh et al., "Health Monitoring and Management Using Internet-of-Things (IoT) Sensing with Cloud-Based Processing: Opportunities and Challenges," 2015 IEEE International Conference on Services Computing, New York, NY, 2015, pp. 285–292.
- [37]. ISO/IEC 25010 - Systems and software engineering - Systems and software Quality Requirements and Evaluation (SQuARE) - System and software quality models Technical Report (2010)
- [38]. G. White, V. Nallur S. Clarke. 'Quality of service approaches in IoT: a systematic mapping'. *J Syst Softw.* 2017;132:186–203.
- [39]. E. Kaimakamis et al., 'Experience of Using the WELCOME Remote Monitoring System on Patients with COPD and Comorbidities', *Precision Medicine Powered by pHealth and Connected Health. ICBHI 2017. IFMBE Proceedings*, vol 66. Springer, Singapore
- [40]. A guide to GDPR data privacy requirements, <https://gdpr.eu/dataprivacy/>.
- [41]. F. D. Hudson, P. A. Laplante and B. Amaba, "Enabling Trust and Security: TIPSS for IoT," in *IT Professional*, vol. 20, no. 2, pp. 15–18, Mar./Apr. 2018. doi: 10.1109/MITP.2018.021921646
- [42]. The HIPAA Privacy Rule. [Online]. Available: <https://www.hhs.gov/hipaa/for-professionals/privacy/index.html>
- [43]. P. Carter, GT.Laurie, M. Dixon-Woods, "The social licence for research: why care.data ran into trouble," in *J Med Ethics*. 2015;41(5):404–9.
- [44]. J.M.M. Rumbold, et al., 'Big data and diabetes: the applications of big data for diabetes care now and in the future,' in *Diabetic Medicine.*, 2019. ISSN 0742-3071
- [45]. J. Kiljander et al., "Semantic Interoperability Architecture for Pervasive Computing and Internet of Things," in *IEEE Access*, vol. 2, pp. 856–873, 2014.
- [46]. K. Park, J. Park, J. Lee, "An IoT System for Remote Monitoring of Patients at Home". *Appl. Sci.* 2017, 7, 260.
- [47]. C. Pereira, A. Aguiar, "Towards efficient mobile M2M communications: survey and open challenges," in *Sensors*. 2014;14(10):19582–608.
- [48]. S.G. Tzafestad, "Ethics and law in the internet of things world," in *Smart Cities*. 2018;1(1):98–120.
- [49]. C. Seeger, K. Van Laerhoven and A. Buchmann, "MyHealthAssistant: An Event-driven Middleware for Multiple Medical Applications on a Smartphone-Mediated Body Sensor Network," in *IEEE Journal of Biomedical and Health Informatics*, vol. 19, no. 2, pp. 752–760, March 2015.

- [50]. R. Zgheib, et al., “**Semantic Middleware Architectures for IoT Healthcare Applications, Enhanced Living Environments**. Lecture Notes in Computer Science, 2019, vol 11369. Springer, Cham.
- [51]. M. A. A. da Cruz, Joel J. P. C. Rodrigues, et al., , ‘**Performance evaluation of IoT middleware**’, Journal of Network and Computer Applications, Volume 109, 1 May 2018, Pages 53-65.
- [52]. T. Chomutare, L. Fernandez-Luque, et al., “ **Features of Mobile Diabetes Applications: Review of the Literature and Analysis of Current Applications Compared Against Evidence-Based Guidelines**”, J Med Internet Res 2011;13(3).
- [53]. R. Goffredo, D. Accoto, M. Santonico, G. Pennazza and E. Guglielmelli, “**A smart pill for drug delivery with sensing capabilities**”, 37th Annual International Conference of the IEEE Engineering in Medicine and Biology Society (EMBC), Milan, 2015, pp. 1361-1364.
- [54]. Ra et al., “**AsthmaGuide: an asthma monitoring and advice ecosystem**,” 2016 IEEE Wireless Health (WH), Bethesda, MD, 2016, pp. 1-8.
- [55]. T. Antonio, et al., “**Tricoli, Noushin Nasiri, Sayan De, Wearable and Miniaturized Sensor Technologies for Personalized and Preventive Medicine**,” in Advanced Functional Materials, February 2017, DOI: 10.1002/adfm.201605271, pp. 1- 19
- [56]. M. Marie-Valérie and H. Edouard, “**Evaluation on Phantoms of the Feasibility of a Smart Bra to Detect Breast Cancer in Young Adults**,” in Sensors. 2019 Dec; 19(24): 5491.
- [57]. M. G. Eshghi, Z. Fruhideh, V. M. Alviri and M. Modarresi Asem, “**Electrochemical Biosensors for Cancer Detection Using Different Biomarkers**,” 2019 IEEE 9th Annual Computing and Communication Workshop and Conference (CCWC), Las Vegas, NV, USA, 2019, pp. 0989-0996..
- [58]. C. Ornetzeder, F. Reiterer, M. B. Christensen, K. Nørgaard, G. Freckmann and L. del Re, “**Feasibility of Fully Closed Loop Insulin Delivery in Type 2 Diabetes**,” 2019 IEEE Conference on Control Technology and Applications (CCTA), Hong Kong, China, 2019, pp. 906-913..
- [59]. P. Sever and M. Niculescu, “**Portable Optical Coagulation Analyzer Based on Real-Time Image Processing Algorithm**,” 2019 11th International Symposium on Advanced Topics in Electrical Engineering (ATEE), Bucharest, Romania, 2019, pp. 1-6.
- [60]. T. Aledavood, et al., “**Smartphone-Based Tracking of Sleep in Depression, Anxiety, and Psychotic Disorders**,” Curr Psychiatry Rep 21, 49 (2019). <https://doi.org/10.1007/s11920-019-1043-y>
- [61]. H. S. Gauvin, et al., “**Verbal monitoring in Parkinson’s disease: A comparison between internal and external monitoring**,” PLoS ONE (2017) 12(8): e0182159. <https://doi.org/10.1371/journal.pone.0182159>.
- [62]. R. José J. R. Barata, Roberto Munoz, Rafael D. de Carvalho Silva, Joel J. P. C. Rodrigues, and Victor Hugo C. de Albuquerque, “**Internet of Things based on Electronic and Mobile Health Systems for Blood Glucose Continuous Monitoring and Management**”, IEEE Access Journal, Vol. 7, N. 1, December 2019, pp. 175116-175125, DOI: 10.1109/ACCESS.2019.2956745.
- [63]. F. Bonomi, R. Milito, J. Zhu, S. Addepalli, “**Fog Computing and Its Role in the Internet of Things**,” Proceedings of the first edition of the MCC workshop on Mobile cloud computing, August 2012, Helsinki, Finland.
- [64]. H. Hayajneh, et al. **A survey of wireless technologies coexistence in WBAN**: Analysis and open research issues, Wireless Networks 20(8): Nov 2014.
- [65]. M. A. A. da Cruz, Joel J. P. C. Rodrigues, Jalal Al-Muhtadi, Valery Korotaev, Victor Hugo C. Albuquerque, “**A Reference Model for Internet of Things Middleware**”, in IEEE Internet of Things Journal, IEEE, ISSN: 2327-4662, Vol. 5, No. 2, April 2018, pp. 871-883, DOI: 10.1109/JIOT.2018.2796561
- [66]. **The New European Interoperability Framework (EIF)**. [Online]. Available: https://ec.europa.eu/isa2/eif_en.
- [67]. ISO/IEC 21823-1:2019 – Interoperability for IoT systems – Part 1: Framework. [Online]. Available: <https://www.iso.org/standard/71885.html>.
- [68]. S. Kumar, et al., “**Internet of Things is a revolutionary approach for future technology enhancement: a review**,” in J Big Data 6, 111 (2019). <https://doi.org/10.1186/s40537-019-0268-2>
- [69]. M. Imran, S. Jabbar, N. Chilamkurti, J. J. P. C. Rodrigues, “**Enabling technologies for Social Internet of Things**”, in Future Generation Computer Systems, Elsevier, ISSN: 0167-739X, Vol. 92, March 2019, pp. 715-717, DOI: 10.1016/j.future.2018.11.018.